



Instruction Manual



IQ+FLOW[®] series **Digital Mass Flow / Pressure Controllers** **for gases**

Doc. no.: 9.17.045V Date: 26-11-2018



ATTENTION

**Please read this Instruction Manual carefully before installing and operating the instrument.
Not following the guidelines could result in personal injury and/or damage to the equipment.**



Copyright

© 2018 Bronkhorst High-Tech B.V.

All rights reserved. No part of this publication may be reproduced, distributed, or transmitted in any form or by any means, without the prior written permission of the publisher.

Disclaimer

This document has been reviewed and is believed to be accurate. Bronkhorst High-Tech B.V. does not assume liability for errors, inaccuracies or absence of information. The material in this document merely serves information and illustration purposes; no rights can be derived from its contents.

Bronkhorst High-Tech B.V. reserves the right to modify or improve its products and documentation without informing anyone. The information contained in this document is subject to change without notice. Device specifications and the contents of the package may deviate from what is stated in this document.

Symbols



Important information. Disregarding this information could cause injuries to people or damage to the instrument or installation.



Helpful information. This information will facilitate the use of the instrument and/or contribute to its optimal performance.



Additional info available on the internet or from your local Bronkhorst representative.

Receipt of equipment

Check the outside package box for damage incurred during shipment. If the box is damaged, then the local carrier must be notified at once regarding his liability, if so required. At the same time a report should be submitted to your local Bronkhorst representative.

Carefully remove the equipment from the box. Verify that the contents of the package was not damaged during shipment. Should the equipment be damaged, then the local carrier must be notified at once regarding his liability, if so required. At the same time a report should be submitted to your local Bronkhorst representative.



- *Check the packing list to ensure that you received all of the items included in the scope of delivery*
- *Do not discard spare or replacement parts with the packaging material*

Refer to [Removal and return instructions](#) about return shipment procedures.

Equipment storage

The equipment should be stored in its original package in a cupboard warehouse or similar. Care should be taken not to subject the equipment to excessive temperatures or humidity.

Warranty

Bronkhorst® products are warranted against defects in material and workmanship for a period of three years from the date of shipment, provided they are used in accordance with the ordering specifications and not subject to abuse or physical damage. Products that do not operate properly during this period may be repaired or replaced at no charge. Repairs are normally warranted for one year or the balance of the original warranty, whichever is the longer.



See also section 9 (Guarantee) of the Conditions of sales:
www.bronkhorst.com/about/conditions-of-sales/

The warranty includes all initial and latent defects, random failures, and indeterminable internal causes.

It excludes failures and damage caused by the customer, such as contamination, improper electrical hook-up, physical shock etc.

Re-conditioning of products primarily returned for warranty service that is partly or wholly judged non-warranty may be charged for.

Bronkhorst High-Tech B.V. or affiliated company prepays outgoing freight charges when any part of the service is performed under warranty, unless otherwise agreed upon beforehand, however, if the product has been returned collect to our factory or service center, these costs are added to the repair invoice. Import and/or export charges, foreign shipping methods/carriers are paid by the customer.

General safety precautions

This product is intended for use by qualified personnel who recognize shock hazards and are familiar with the safety precautions required to avoid possible injury. Read the operating information carefully before using the product.

Before operating, make sure the line cord is connected to a properly grounded power receptacle. Inspect the connecting cables for cracks or breaks before each use.

The equipment and accessories must be used in accordance with their specifications and operating instructions, otherwise the safety of the equipment may be impaired.

If required, replace fuses with the same type and rating for continued protection against fire hazard.

Opening the equipment is not allowed. There are no user serviceable parts inside. In case of a defect please return the equipment to Bronkhorst High-Tech B.V.

One or more warning signs may be present on different parts of the product. These signs have the following meaning:



Consult the instruction manual for handling instructions



Surface may get hot during operation



Shock hazard; electrical parts inside

To maintain protection from electric shock and fire, replacement components must be obtained from Bronkhorst. Standard fuses, with applicable national safety approvals, may be used if the rating and type are the same. Other components that are not safety related may be obtained from other suppliers, as long as they are equivalent to the original component. Selected parts should be obtained only through Bronkhorst, to maintain accuracy and functionality of the product. If you are unsure about the relevance of a replacement component, contact your local Bronkhorst representative for information.

Table of contents

1	Introduction	7
1.1	Scope of this manual	7
1.2	Product description	7
1.3	Other documentation	7
2	Starting up	8
2.1	Check properties	8
2.2	Check pressure rating	8
2.3	Check piping	8
2.4	Install system	9
2.5	Leak check	9
2.6	Electrical connection	9
2.7	Analog / digital operation	10
2.8	Multi-functional switch operation	10
2.9	Purging	10
2.10	Zeroing	11
2.11	Calibration	11
2.12	Supply pressure	11
2.13	Model key	12
2.13.1	Model key IQF / IQP	12
2.13.2	Model key IQM	12
3	Basic operation	13
3.1	General	13
3.2	Analog operation	13
3.3	Manual interface: micro-switch, LEDs and rotary switches	14
3.3.1	Micro-switch operation (single-channel versions only)	14
3.3.2	LED functions	16
3.3.3	Rotary switch operation (multi-channel versions only)	16
3.4	Basic RS232 operation	17
3.4.1	Hook-up	17
3.4.2	Dynamic Data Exchange (DDE)	17
3.4.3	FlowDDE	17
3.4.4	Software	18
3.4.5	FlowDDE parameter numbers	18
3.4.6	Baud rate setup	18
3.5	Basic RS485 operation	18
3.5.1	Hook-up	19
3.5.2	Software	20
3.5.3	Slave address, baud rate and parity setup	20
3.6	Basic parameters and properties	21
3.6.1	Introduction	21
3.6.2	Basic measurement and control parameters	22
3.6.3	Basic identification parameters	22
4	Advanced operation	23
4.1	Reading and changing instrument parameters	23
4.1.1	Special parameters	23
4.1.2	Fluid information	24

4.1.3	Advanced measurement and control parameters	25
4.1.4	Controller parameters	25
4.1.5	Display filter	26
4.1.6	Alarm / Status parameters	27
4.1.7	Counter parameters	27
4.2	Special instrument features	27
4.2.1	Auto zeroing	27
4.2.2	Changing default control mode	28
4.2.3	Disabling micro switch (single-channel versions only)	28
4.2.4	Setting digital output (multi-channel versions only)	29
4.2.5	Changing slave address, baud rate and parity	29
5	Troubleshooting and service	31
5.1	General	31
5.2	LED indication	31
5.3	Troubleshooting summary general	31
5.4	Service	32
6	Returns	33
6.1	Removal and return instructions	33
6.2	Disposal (end of lifetime)	33

1 Introduction

1.1 Scope of this manual

This manual covers the IQ+FLOW® series Digital Mass Flow / Pressure Controllers for gases. It includes product information, installation instructions, operation, maintenance and troubleshooting.



1.2 Product description

The IQ+FLOW® series is one of the smallest mass flow, chip based, instruments of its kind for applications with pressure conditions up to 10 bar (145 psi) and temperatures between 5 to 50 °C (41 to 122 °F). Due to the use of micro system technology, ultra compact flow controllers are realised with dimensions of only 20 x 40 x 60 mm. The (IQF) flow controllers are able to measure and control flow rates of 10 mln/min FS up to 5 l/min FS. The (IQP) pressure controllers are available in ranges from 0.3 to 150 psi (0.02 to 10 bar). The IQ+FLOW® series has a modular concept with combinations of 20 mm footprint modules, available as single instruments, but also as multiple channel arrangements. A very compact manifold (IQM) system can be constructed, with one multi-channel digital pc-board (per 3 channels) in a single housing. Additional filters, control valves and shut-off valves are available with the same footprints to meet customer demands. The IQF flow sensor is a fast-response chip sensor, with the main advantage of fast and reliable control response. This is possible due to the MBC3-based pc-board and the flow sensor, which output signal very accurately corresponds with the real flow behavior.

Communication with the devices can be either in analog mode or digital over RS232 or RS485. Communication over RS232 is established with the Propar (FLOW-BUS) protocol. With digital operation over RS485 a bus-system with multiple instruments can be set up. Modbus RTU/ASCII and FLOW-BUS protocols are supported (some exceptions for multi-channel versions, see **section 3**).

1.3 Other documentation

Instructions:

- IQ+FLOW® Quick Installation Guide (document no. 9.17.074)
- Operation instructions digital instruments (document no. 9.17.023)
- RS232 interface with FLOW-BUS for digital instruments (document no. 9.17.027)
- Modbus slave interface for digital Mass Flow / Pressure instruments (document no. 9.17.035)

Technical drawings:

- Hook-up diagram IQ+FLOW® RS232/RS485 + Analog I/O (document no. 9.16.101)
- Hook-up diagram IQ+FLOW® Manifold (multi-channel) (document no. 9.16.090)
- Dimensional drawing IQF/IQP (document no. 7.05.870)
- Dimensional drawing IQFD/IQPD (document no. 7.05.871)
- Dimensional drawing IQM (document no. 7.05.760)



These documents can be downloaded from www.bronkhorst.com/downloads and are available by request at our local sales & service representatives

2 Starting up

2.1 Check properties

Before installing the IQ+FLOW®, check that the product specifications match your requirements:

- Instrument type
 - red label: gas flow (IQF)
 - yellow label: pressure (IQP)
- Flow/pressure rate
- Media to be used in the instrument
- Input and output signal
- Upstream and downstream pressure(s)
- Operating temperature



Note that the serial number shown on the right does not necessarily reflect the actual specifications.



- IQ+FLOW® gas flow instruments are designed for dry, clean, non-corrosive gases
- IQ+FLOW® pressure instruments are designed for dry, clean, non-corrosive, non-flammable gases

Do not use the IQ+FLOW® for other gas types.

If you have a question about the product or if you feel the product does not meet the specifications agreed upon, do not hesitate to contact us. To enable us to help you quickly and effectively, make sure to have the serial number ready whenever seeking contact with Bronkhorst about a specific item. The serial number (SN) is the key to the original purchase order.

See section [Service](#) for contact information.

2.2 Check pressure rating



Bronkhorst® instruments are pressure tested to at least 1.5 times the specified working process conditions and outboard leak tested to at least $2 * 10^{-9}$ mbar l/s Helium. The tested pressure is specified on the instrument with a red label.

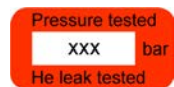

- Before installation, make sure that the tested pressure is in accordance with the safety factor of your application
- If the pressure test label is missing or if the specified pressure is insufficient, the instrument must not be used and should be returned to the factory
- The maximum operating pressure must never exceed the tested pressure
- Disassembling the instrument and/or replacing parts of it will invalidate the pressure test specification.

2.3 Check piping



For reliable measurement, always make sure that the fluid stream is clean. Use filters to ensure a clean, moisture- and oil-free gas stream. Recommended pore-size: 7 µm. If back flow can occur, a downstream filter is recommended too. Be aware of the pressure drop caused by using filters.



2.4 Install system

For IQ+FLOW® installation in an upright position is preferred. When using an IQ+FLOW® [gas flow instrument](#) in a position with upward or downward flow, [adjusting the zero point](#) prior to first use is recommended. Avoid installation in close proximity of mechanic vibration and/or heat sources. The housing of the instrument has ingress protection class IP40, which means that the instrument is suitable for indoor (dry) applications, like laboratories or machine enclosures.

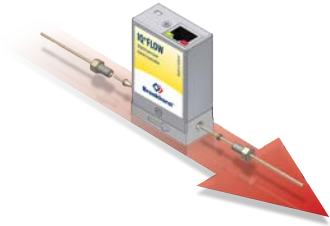

Install the IQ+FLOW® instrument in the line, in accordance with the direction of the FLOW arrow on the base of the instrument. If applicable follow the guidelines of the supplier of the fittings. Special types of fittings are available on request.



Compression type fittings

For leak tight installation of compression type fittings make sure that the tube is inserted up to the shoulder in the fitting body and that no dirt or dust is present on tube, ferrules or fittings. Tighten the nut finger tight; while holding the instrument, then tighten the nut one turn.

10-32 UNF fittings

Tighten the 10-32 UNF fittings according to the instructions of the supplier of the fittings.

Only use 1/16" tubing with a straight and clean cut without burrs to ensure leak tightness. Preferably deburr the tubing prior to installation. A new ferrule connection must be made for each new adapter to ensure leak-tightness and minimum dead volume, due to variances in the adapter dimensions.

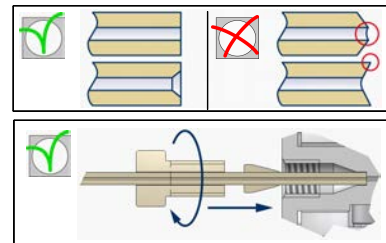

Mounting downported instruments

For downported instruments make sure that the seals are present at the bottom, that the surfaces are undamaged and that they are dry and free from dirt or dust.

2.5 Leak check



Check the fluidic system for leaks before applying pressure, especially when using hazardous media (e.g. toxic or flammable).

2.6 Electrical connection



Electrical connections must be made with a standard cable, according to the IQ+FLOW® hook-up diagram. Several hook-up examples and standard cables can be found in **section 3**. IQ+FLOW® instruments are powered with +15...+24 Vdc.



The device contains electronic components that are susceptible to damage by **electrostatic discharge**. Proper handling procedures must be followed during installation, (dis)connecting and removing the electronics.

The devices described in this manual carry the CE-mark and are **compliant with the concerning EMC requirements**. However, compliance with the EMC requirements is not possible without the use of proper cables and connector/gland assemblies. Bronkhorst recommends the use of their standard cables. These cables have the right connectors and if loose ends are used, these are marked to help prevent wrong connection. When using other cables, cable wire diameters should be sufficient to carry the supply current, and voltage loss must be kept as low as possible. When in doubt, contact your local Bronkhorst representative.

When connecting products to other devices, be sure that the integrity of the shielding is not affected; **always use shielded cabling for signals and communication and do not use unshielded wire terminals**.

2.7 Analog / digital operation



Analog operation (single channel versions only)

For analog operation refer to the "Hook-up diagram IQ+FLOW®" or use an RJ-45 loose-end cable (7.03.419) to connect the required signals.

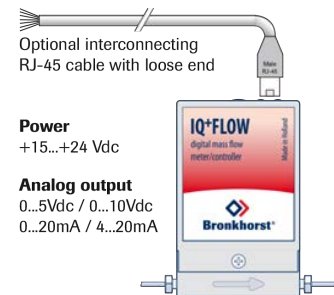

Digital RS232 operation

Digital operation over RS232 can be established when using the following setup. Using a RS232 cable or a USB-RS232 converter with a PC will allow you to use (free) Bronkhorst® software for Windows, such as FlowDDE and FlowPlot. See also **section 3.4**.

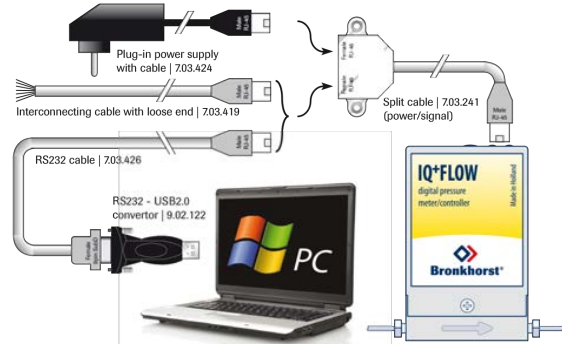

Digital RS485 operation

With digital operation over RS485 a bus-system with multiple instruments can be set up. See **section 3.5** for possible systems.

2.8 Multi-functional switch operation



Micro-switch operation (single channel versions only)

Using the micro-switch on the instruments, several actions can be monitored and started. The green LED is used for status indication. The red LED is used for errors/warnings/messages. The micro-switch can be used to start several actions, such as auto-zero, restore factory settings and bus-initialisation actions, if applicable. See specific zero-procedure below and **section 3.3** for more details.

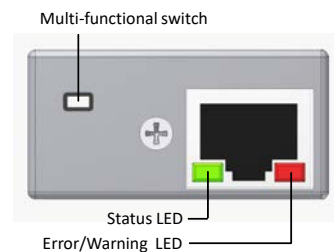

Rotary switch operation (multi-channel versions only)

Select the communication type and Baud rate with the "COMM. TYPE" switch. Select the node address with the "MSD" and "LSD" switch (e.g. MSD = 1 and LSD = 9 selects node 19 for channel 1, but also node 20 and 21 for channels 2 and 3). See **section 3.3** for more details.

2.9 Purging



Do not apply pressure until electrical connections are made. When applying pressure to the system, avoid pressure shocks in the system and increase pressure gradually. Also decrease pressure gradually when required.



In systems for use with corrosive or reactive media, purging for at least 30 minutes with a dry, inert gas (like Nitrogen or Argon) is absolutely necessary before use. After use with corrosive, reactive or hazardous media (e.g. toxic or flammable), purging is also necessary before the system is exposed to air.



For best accuracy, allow the IQ+FLOW® to warm up and stabilize for at least 30 minutes before starting measurement and/or control of the fluid stream(s). This may be done with or without gas flow.

2.10 Zeroing



The zero point of each flow meter/controller is factory adjusted. If required the zero point can be re-adjusted over RS232 or by means of the micro-switch. Procedure for zeroing by-micro-switch (not for pressure meter/controller):

- Warm-up, pressure up the system and fill the instrument according to the process conditions.
- Make sure no flow is going through the instrument by closing valves near the instrument.
- The setpoint must be zero.
- Press micro-switch and hold it. After a short time the red LED will go ON and OFF, then the green LED will go ON. At that moment release the micro-switch.
- The zeroing procedure will start at that moment and the green LED will blink fast. The zeroing procedure waits for a stable signal and saves the zero. If the signal is not stable, zeroing will take long and the nearest point to zero is accepted. The procedure will take approximately 10 seconds.
- When the indication is showing 0% signal and the green indication LED is burning continuously again, the zeroing action was successful.

2.11 Calibration

Each IQ+FLOW® instrument is factory calibrated. Bronkhorst certifies that all instruments meet the rated accuracy. Calibration is performed using measurement standards traceable to the standards of the Dutch Metrology Institute (VSL). Calibration certificates are included in the shipment. When operated properly (clean gas, no pressure shocks, no vibrations, no thermal shocks, etc.), regular maintenance is not required. However, periodical inspection, recalibration or verification of the accuracy may be subject to individual requirements of the end-user.

2.12 Supply pressure



It is recommended to turn on power before applying pressure and to switch off power after removing pressure.



Be sure to apply the specified operating pressure(s). Avoid pressure shocks and bring the fluidic system gradually up to the level of operating conditions; open and close the fluid supply gently.

2.13 Model key

2.13.1 Model key IQF / IQP

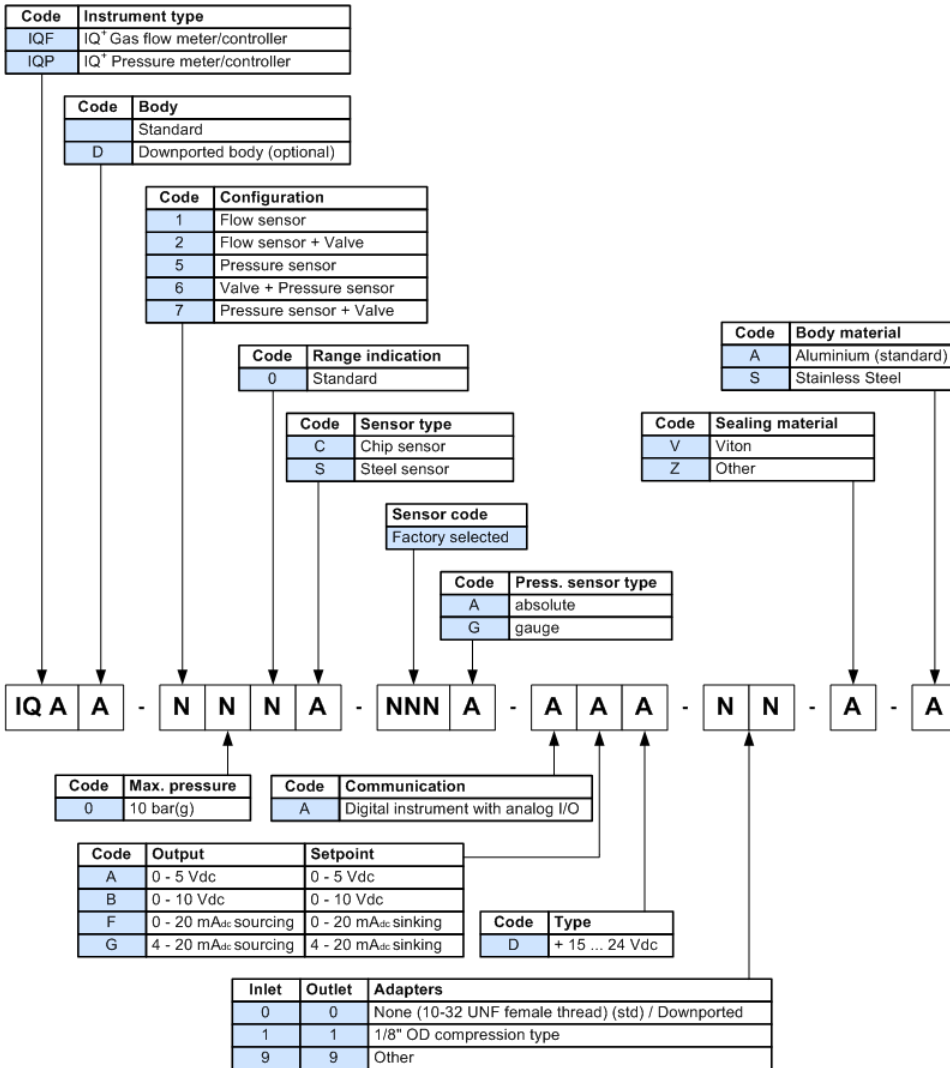

2.13.2 Model key IQM

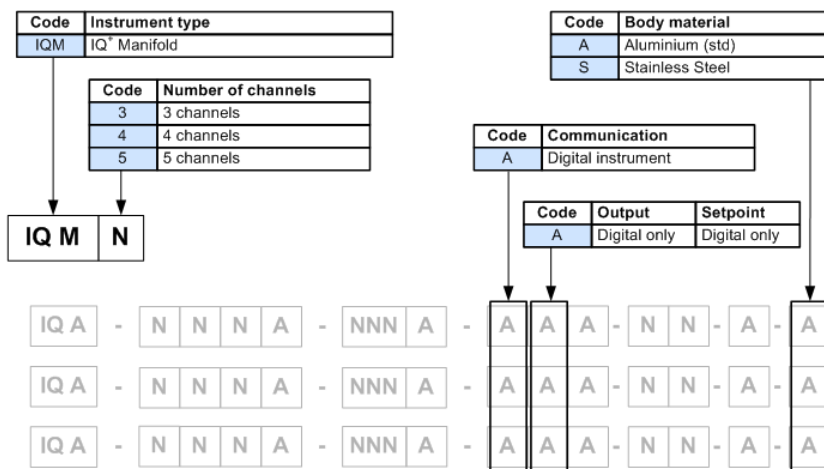

* Each channel of an instrument will be provided an additional letter after the serial number (e.g. M#####AA).

3 Basic operation

3.1 General

An IQ+FLOW® instrument must be powered with +15...+24 Vdc according to the applicable hook-up diagram, supplied with the instrument. The instrument can be operated by means of:

- Analog interface: 0...5 Vdc; 0...10 Vdc; 0...20 mA or 4...20 mA (single-channel versions only)
- Digital RS232 interface (FLOW-BUS (Propar) protocol)
- Digital RS485 interface (Modbus RTU, Modbus ASCII or FLOW-BUS protocols)

By default the instrument is set as specified. The table below lists the supported interfaces for single-channel and multi-channel versions.

	Analog interface (section 3.2)	Digital RS232 interface (section 3.4)	Digital RS485 interface (section 3.5)
IQF/IQP (single-channel)	0...5 Vdc; 0...10 Vdc; 0...20 mA; 4...20 mA (software selectable)	FLOW-BUS (Propar) protocol on 9600, 19200, 38400, 57600 or 115200 Baud (software selectable)	Modbus RTU and Modbus ASCII protocols on 9600, 19200, 38400, 56000, 57600 or 115200 Baud; FLOW-BUS protocol on 187500 or 400000 Baud (software selectable)
IQM (multi-channel)	Not supported	FLOW-BUS (Propar) protocol on 38400 or 115200 Baud (select with rotary switch)	Modbus RTU protocol on 9600, 19200 or 38400 Baud (select with rotary switch)

3.2 Analog operation

Analog operation is only possible with single-channel IQ+FLOW® instruments. Multi-channel instruments can only be operated digitally. At analog operation the following signals are available:

- Measured value (analog output) at pin 2
- Setpoint (analog input/setpoint) at pin 3

The valve output is no longer available as analog signal with IQ+FLOW®. The selected analog interface (0...5 Vdc; 0...10 Vdc; 0...20 mA or 4...20 mA) can be found in the model key of the instrument. Refer to **Section 2.13**.



When operating the instrument through the analog interface it is possible to connect the instrument simultaneously to RS232 for reading/changing parameters (e.g. settings or fluid selection).

Hook-up

For analog operation either an RJ-45 loose-end cable or an RJ-45 to 9-pin sub-D converter may be used to connect the required signals.

Refer to the "Hook-up diagram IQ+FLOW®" or use an RJ-45 loose-end cable (7.03.419) to connect the required signals.

When using a Bronkhorst® readout unit use only an RJ-45 cable (7.03.236) in combination with the RJ-45 to 9-pin sub-D converter (7.03.376). With these items the pin configuration is unchanged.

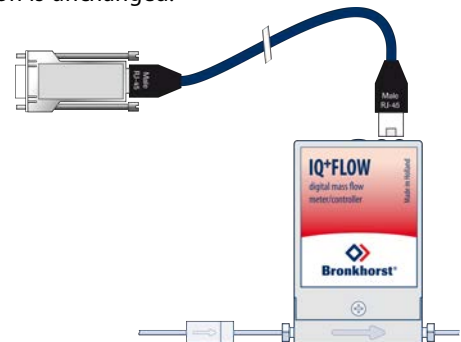
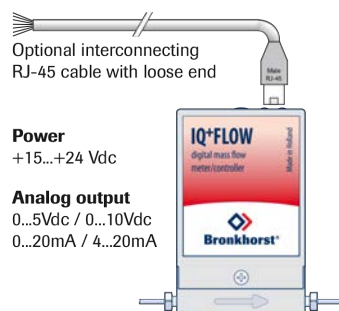

3.3 Manual interface: micro-switch, LEDs and rotary switches

In this section the manual instrument interfaces are described:

- [Micro-switch](#)
- [Indication LEDs](#)
- [Rotary switch](#)

3.3.1 Micro-switch operation (single-channel versions only)

By means of manual operation of the micro push-button switch some important actions for the instrument can be selected or started. These options are available in both analog and digital operation mode.

These functions are:

- Reset alarm
- Reset instrument (firmware program reset)
- Auto-zeroing
- Restore factory settings (in case of accidentally changing of the settings)

Using digital RS232 or RS485 operation it is also possible to set:

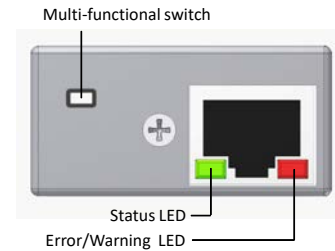

- Bus-address (only required for RS485)
- Baudrate
- Change control mode



The tables below describe the micro-switch functions that can be started in normal operation mode and during power-up:

LEDs		Time Pushed	Indication
Green ■	Red ■		
Off	Off	0 – 1 sec.	No action. Pressing a switch shortly by accident will not start any unwanted reaction of instrument. Pressing the switch 3x briefly with intervals of max. 1 sec. forces the instrument to indicate its bus-address and baud rate. Check section 3.5 for more details.
Off	Off	1 – 4 sec.	In case of min/max alarm or counter batch reached: Reset alarm (only if reset by keyboard has been enabled) For FLOW-BUS only: if the node address is occupied, this function will install a free node-address on FLOW-BUS.
Off	On	4 – 8 sec.	Reset instrument Instrument program will be restarted and all warning and error messages will be cleared. During start-up the instrument will perform a (new) self-test.
On	Off	8 – 12 sec.	Auto-zero Instrument will be re-adjusted for measurement of zero-flow (not for pressure meter/controller). See section 2.10 .
On	On	12 – 16 sec.	Prepare instrument for FLASH mode for firmware update. Instrument shuts down and both LEDs turn off. At next power-up instrument will be active again.

LED indications using micro-switch at normal operation mode of an instrument



LEDs		Time Pushed	Indication
Green 	Red 		
Off	Off	0 – 4 sec.	No action. Pressing a switch shortly by accident will not start any unwanted reaction of the instrument.
Off	Normal flash 0,2 sec on, 0,2 sec off	4 – 8 sec.	Restore factory settings All parameter settings (except field bus settings) will be restored to situation of final test at Bronkhorst® production.
Normal flash 0,2 sec on, 0,2 sec off	On	8 – 12 sec.	For FLOW-BUS only: install a free node-address on FLOW-BUS.
Normal flash 0,2 sec on, 0,2 sec off	Normal flash 0,2 sec on, 0,2 sec off	12 – 16 sec	Activate 'Configuration Mode'. The baud rate and bus type are set to 38k4 and RS232 FLOW-BUS (Propar). The 'Configuration Mode' is recognized by the green LED blinking 2 sec on, 0,1 sec off. The 'Configuration Mode' is deactivated only after applying this micro-switch action again.

LED indications using micro-switch at power-up situation of an instrument

Change control mode

For switching between different functions in use of a digital meter or controller several modes are available. More information about the available control modes can be found at parameter "Control mode".

Pressing the switch 4x briefly with intervals of max. 1 second in normal running/operation mode will trigger the instrument to "change" its control mode.

Change current control mode (press switch 4x briefly)				
Step	Action	Indication	Time	Handling
1	Set tens of setpoint / control mode number	 green LED flashes 0.1 sec on 0.1 sec off Count-flashes start when switch is pressed: 0.5 sec on 0.5 sec off	time-out: 60 sec	Press switch and count green flashes for tens of control mode number. Release when wanted amount has been count. Counts up to max. 2 and than starts at 0 again. When counting fails, keep switch pressed and restart counting for next attempt
2	Set units of setpoint / control mode number	 red LED flashes 0.1 sec on 0.1 sec off Count-flashes start when switch is pressed: 0.5 sec on 0.5 sec off	time-out: 60 sec	Press switch and count red flashes for units of control mode number. Release when wanted amount has been count. Counts up to max. 9 and than starts at 0 again. When counting failed, keep switch pressed and restart counting for next attempt.

Instrument returns to normal running/operation mode.

Changes are valid when they are made within the time-out times.

See parameter 'Control mode' for behavior at power-up of the instrument.



Value zero will be indicated by a period of 1 sec. off (0.5 sec. off + 0.5 sec. off).
When value zero is wanted, press switch shortly and release it again within 1 sec.



Before each action of flash-counting, the LED's to be used for counting will flash in a high frequency.
(Pattern: 0.1 sec on, 0.1 sec off). As soon as the switch is pressed-down, this LED (or both LED's) will be off and the counting sequence will start.

3.3.2 LED functions

The LEDs on top of the instrument can also be used for manual operation of some options. The green LED will indicate in what mode the instrument is active. The red LED will indicate error/warning situations.



For details see chapter **“Manual interface: micro-switch and LEDs”** in [Operation Instructions Digital Instruments \(document no 9.17.023\)](#)

3.3.3 Rotary switch operation (multi-channel versions only)

The IQ+FLOW® multi-channel instruments are equipped with rotary switches for selection of communication type, baud rate and node address.

Communication type switch

With the 'COMM. TYPE' switch the following communication types can be selected:

0. RS485 9k6: Modbus RTU protocol with baud rate 9600, EVEN parity
1. RS485 19k2: Modbus RTU protocol with baud rate 19200, EVEN parity
2. RS485 38k4: Modbus RTU protocol with baud rate 38400, EVEN parity
3. RS232 38k4: FLOW-BUS protocol with baud rate 38400
4. RS232 115k2: FLOW-BUS protocol with baud rate 115200

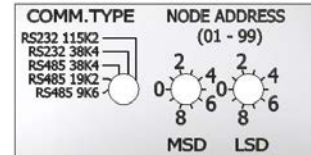

Node address switches

With the two 'NODE ADDRESS' switches the node address of the instrument channels can be selected. The 'MSD' (Most Significant Digit) sets the first digit (tens), the 'LSD' (Least Significant Digit) sets the second digit (units). The node address of channel 1 is set with the switches, the channels 2 and 3 receive 'node address' + 1 and 'node address' + 2 respectively (e.g. MSD = 1 and LSD = 9 selects node 19 for channel 1, but also node 20 and 21 for channels 2 and 3).

3.4 Basic RS232 operation

Digital operation adds a lot of extra features (compared to analog operation) to the instruments, such as:

- Up to eight selectable fluids (if installed)
- Direct reading at readout/control module or host computer
- Testing and self diagnosis
- Identification (serial number, model number, device type, user tag)
- Adjustable minimal and maximal alarm limits
- (Batch) counter

3.4.1 Hook-up

Connecting an IQ+FLOW® instrument to a COM port of a pc requires a special cable (7.03.426) which changes the appropriate pin configuration. Optionally use an RS232 to USB2.0 converter (9.02.122) to connect to a USB port. Use the split cable (Y-adapter 7.03.241) in combination with the Plug-in Power Supply (7.03.424) for powering the instrument.

Instead of using a COM or USB port, it is also possible to connect the RS232 pinning manually using the loose-end cable (7.03.419), typically for connection to PLC or microcontroller devices.

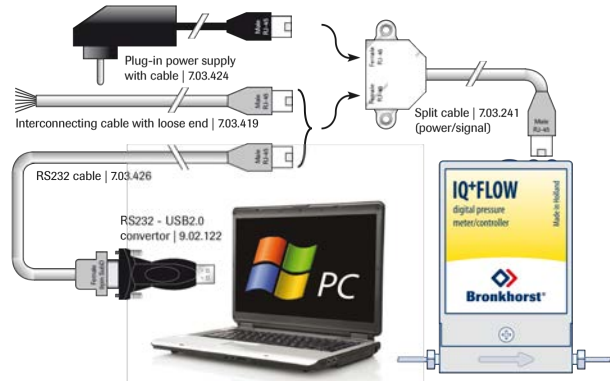

3.4.2 Dynamic Data Exchange (DDE)

RS232 communication can be used for operating the instrument using the Bronkhorst® FlowDDE server application. Dynamic Data Exchange (DDE) provides the user a basic level of interprocess communication between Windows applications. FlowDDE is a DDE server application. Together with a client-application, either self-made or with a SCADA-program from third parties, it is possible to create an easy way of data exchange between the flow controller and a Windows application. For example, a cell in Microsoft Excel could be linked to the measured value of the IQ+FLOW® and when the measured value changes, it will be updated automatically in the Excel spreadsheet.

3.4.3 FlowDDE

The FlowDDE server also offers a lot of test facilities and user-adjustable settings for efficient communication with the connected flow/pressure meter or controller. How to setup a DDE link with FlowDDE is described in the help-file of the FlowDDE application. Programming examples are available for making applications in: Visual Basic, LabView and Microsoft Excel.

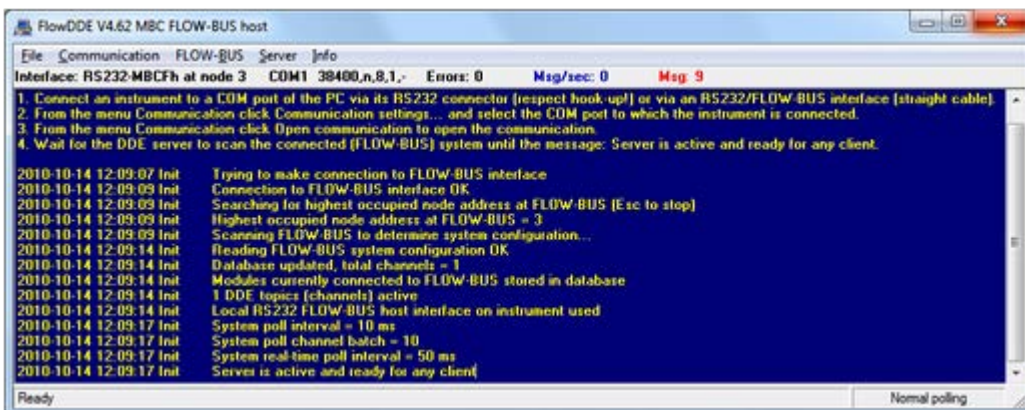

3.4.4 Software

Examples of free Bronkhorst® DDE client applications: FlowPlot and FlowView. Other software programs (third party) supporting DDE are for example MS-Office, LabVIEW, InTouch and Wizcon.

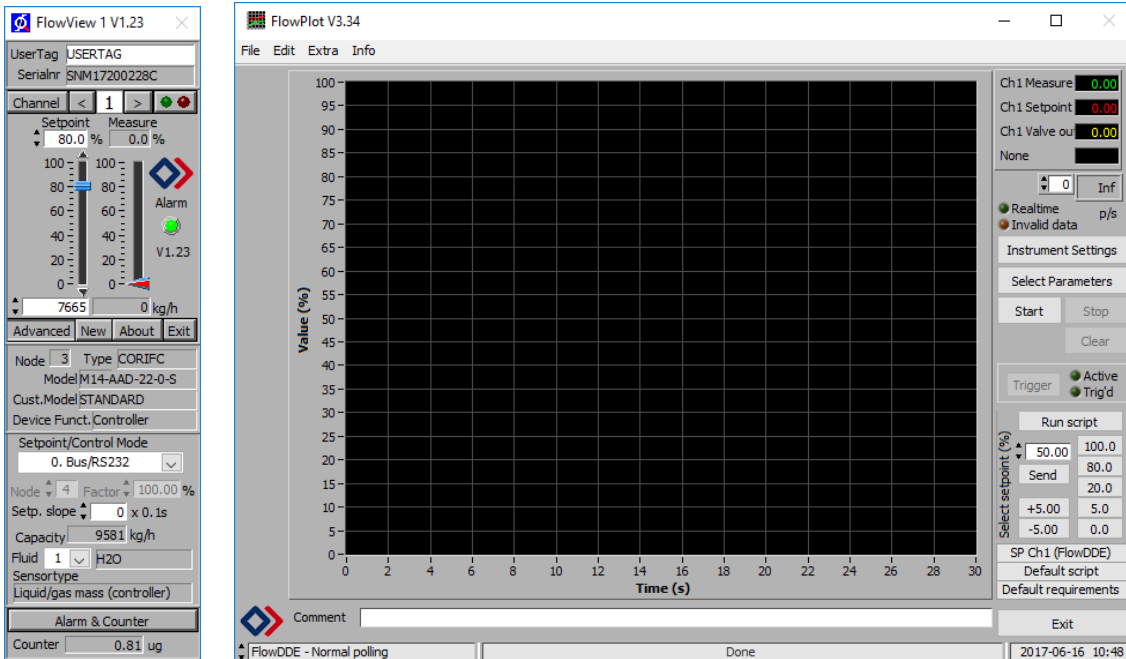

Bronkhorst® software applications 'FlowView' (left) and 'FlowPlot' (right)



FlowDDE and other Bronkhorst® applications are available on the support CD or can be downloaded from the product pages on the Bronkhorst website: www.bronkhorst.com/products

3.4.5 FlowDDE parameter numbers

Reading/changing parameter values via FlowDDE offers the user a different and user-friendly interface to the instrument. A DDE-parameter number is a unique number in a special FlowDDE instruments/parameter database and not the same as the parameter number from the process on an instrument. Node-address and process number will be translated by FlowDDE to a channel number.

An instrument parameter can be changed by using the application name: 'FlowDDE' with only:

- topic, used for channel number: 'C(X)'
- item, used for parameter number: 'P(Y)'

3.4.6 Baud rate setup

Make sure that the instrument's baud rate corresponds with the baud rate of the application the instrument is communicating with. For single-channel instruments the selectable baud rates are 9K6, 19k2, 38k4, 57k6 and 115k2 Baud; for multi-channel instruments the selectable baud rates are 38k4 and 115k2 Baud.



For more information regarding communication through an RS232 interface, consult the [RS232 manual \(document no. 9.17.027\)](#)

3.5 Basic RS485 operation

This section is limited to the description of the interface between the IQ+FLOW® instrument with a master device. IQ+FLOW® instruments always serve as slaves in a Modbus system. There is no mutual communication between Modbus slaves; only between master and slave. The master device is for example a pc.



More detailed information about Modbus can be found at www.modbus.org or any website of the (local) Modbus organisation of your country (when available).

3.5.1 Hook-up

These illustrations show examples of IQ+FLOW® instruments in a RS485 bus-system. When the power consumption is more than 15W, two separate power supplies are required due to the maximum power supply of 15 W for one PiPS.

FLOW-BUS setup

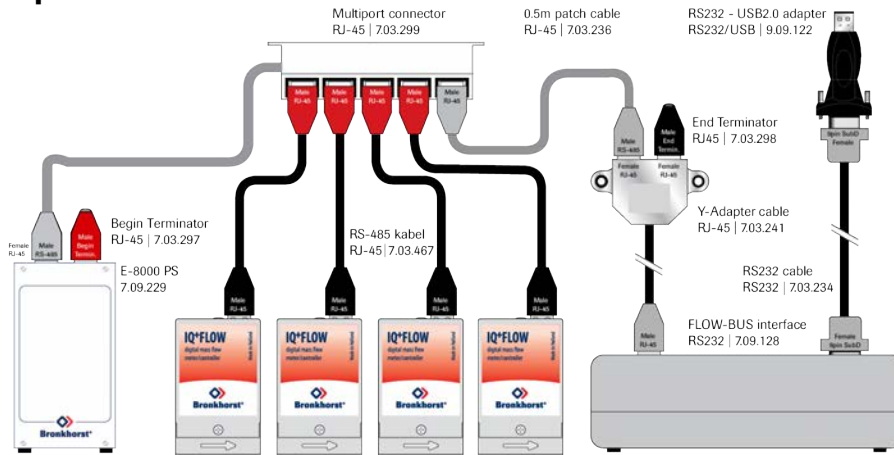

Modbus setup

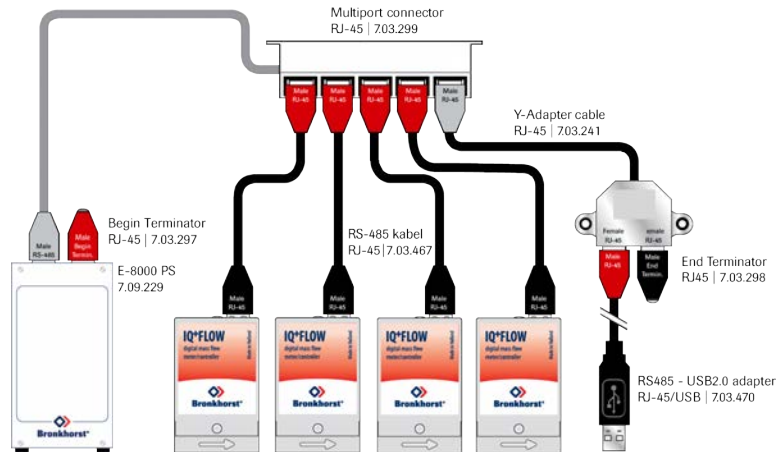

RS232 stand alone setup

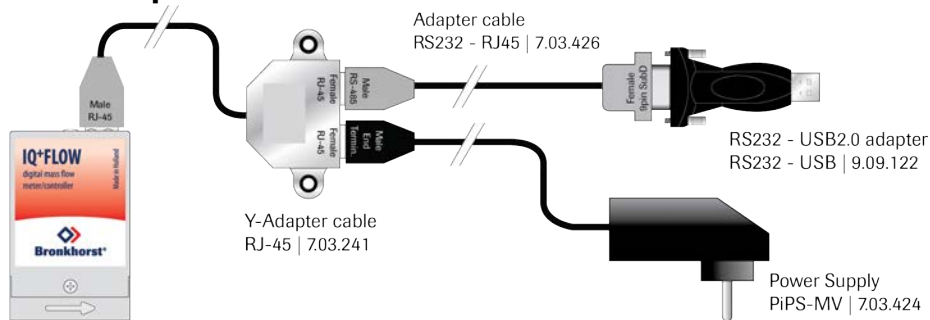

3.5.2 Software

When using a pc to communicate with IQ+FLOW® instruments only the FLOW-BUS protocol is supported by Bronkhorst® software. When using Modbus operation, software from third parties, such as LabVIEW, ModScan or a Modbus PLC must be used to serve as Modbus master.



Note: an IQ+FLOW® instrument set for RS485 FLOW-BUS or Modbus communication will not respond when connecting to an RS232 configuration. When required press the micro-switch according to the procedure in section 3.3.1 at start-up to activate the 'Configuration Mode'. The baud rate and bus type are set to 38k4 and RS232 FLOW-BUS (ProPar). For multi-channel instruments the communication type can be set with the rotary switches.

3.5.3 Slave address, baud rate and parity setup

The IQ+FLOW® instrument is configured as specified on order. If there is a need of changing any of the specified settings, see the tables below for the supported configurations. The default selections are presented in bold.

Single-channel versions

Mode:	Analog	Digital			
Interface/medium:	-	RS232	RS485		
Bus protocol:	-	Propar	FLOW-BUS	Modbus RTU	Modbus ASCII
Baud rate:	-	9600 19200 38400 57600 115200	187500 400000	9600 19200 38400 56000 57600 115200	9600 19200 38400 56000 57600 115200
Node address:	-	3 ...125	3 ...125	1 ...247	1 ...247
Parity:	-	None*	None*	None; Even ; Odd	None; Even ; Odd

In case the baud rate or node address of an IQ+FLOW® instrument needs to be changed, this can be done with the micro-switch or by changing the settings in the 'Configuration Mode'. Other parameters can be changed only in the 'Configuration Mode'. For changing the mentioned parameters with the micro-switch see **Section 4.2.5**. When using the 'Configuration Mode' to change these settings, activate the 'Configuration Mode' by pressing the micro-switch at start-up according the description in **Section 3.3.1**. In 'Configuration Mode' the baud rate and bus type are set to 38k4 and RS232 FLOW-BUS (ProPar). Change the appropriate parameters as described in **Section 4.2.5**. When finished, deactivate the 'Configuration Mode' using the same procedure. Now the instrument is ready to use in desired configuration with the adjusted baud rate, node address or parity.

Multi-channel versions (select with rotary switches)

Mode:	Digital	
Interface/medium:	RS232	RS485
Bus protocol:	Propar	Modbus RTU
Baud rate:	38400 115200	9600 19200 38400
Node address:	3 ...99	1 ...99
Parity:	None*	Even

* Not selectable

3.6 Basic parameters and properties

3.6.1 Introduction

Most instrument parameters can only be accessed with digital communication. For each communication protocol the instrument parameters are accessed differently. When using Bronkhorst® software programs FlowView or FlowPlot, easy access is provided to the mostly used parameters by menu interfaces. When using other communication methods the addressing method for the supported communication protocol is presented for a number of basic parameters in a table as shown below:

Type	Access	Range	FlowDDE	FLOW-BUS	Modbus
[type]	RW 	[x]...[y]	[FB]	[Pro]/[Par]	[address]/[index]

Type

Unsigned char	1 byte character
Unsigned char[x]	x byte array (string)
Unsigned int	2 byte unsigned integer
Unsigned long	4 byte unsigned long
Float	4 byte floating point

Access

R	The parameter is read-only
RW	The parameter can be read and written
RW 	The parameter is protected and can only be written when the 'Init Reset' parameter is set to 64. See section 4.1.1 for more details.

Range

Some parameters only accept values within a certain range:

[x]	Minimum value of the range.
[y]	Maximum value of the range.

FlowDDE

Parameter number within FlowDDE. Refer to **section 3.4** for more information about FlowDDE.

FLOW-BUS

Within the FLOW-BUS protocol (Propar when using RS232) parameters are divided into a 'Process' and a 'Parameter' number. To address parameters using the FLOW-BUS/Propar protocol write both numbers:

[Pro]	Process number
[Par]	Parameter number



For detailed information, consult the [RS232 manual \(document no. 9.17.027\)](#)

Modbus

Parameters can be read or written via the Modbus protocol by specifying either the PDU Address or the register number. The PDU Address is a hexadecimal number (identifiable by the '0x' prefix), which corresponds to the decimal register number minus one, e.g. PDU Address 0x0000 equals register number 1, PDU Address 0x000A equals register number 11 etc.):

[address]	Hexadecimal PDU address
[index]	Decimal register number

For the Modbus protocol every two bytes are addressed separately.

3.6.2 Basic measurement and control parameters

The list below provides the most basic parameters for digital communication with the instrument.



For more detailed information regarding operation parameters, see [Operation Instructions Digital Instruments \(document no 9.17.023\)](#)

Measured Value (Measure)

Type	Access	Range	FlowDDE	FLOW-BUS	Modbus
Unsigned int	R	0...41942	8	1/0	0x0020/33

The 'Measured Value' indicates the amount of mass flow or pressure metered by the instrument. The signal of 0...100% will be presented in a range of 0...32000. The maximum measured value output is 131.07 %, which is: 41942. A floating point variable of the measured value, 'Fmeasure', is also available in the capacity and capacity unit for which the instrument has been set, see **section 4**.

Setpoint

Type	Access	Range	FlowDDE	FLOW-BUS	Modbus
Unsigned int	RW	0...32000	9	1/1	0x0021/34

The 'Setpoint' is used to set the required mass flow rate or pressure for the controller. The signals have the same range as the measured value, only the setpoint is limited between 0 and 100% (0...32000). A floating point variable of the setpoint, 'Fsetpoint', is also available in the capacity and capacity unit for which the instrument has been set, see section 4.

3.6.3 Basic identification parameters

User Tag

Type	Access	Range	FlowDDE	FLOW-BUS	Modbus
Unsigned char[16]	RW	-	115	113/6	0xF130...0xF136/61745...61751

The 'User Tag' parameter allows the user to give the instrument a custom tag name, with a maximum of 16 characters.

Customer Model

Type	Access	Range	FlowDDE	FLOW-BUS	Modbus
Unsigned char[16]	RW	-	93	113/4	0xF120...0xF127/61729...61736

This parameter is used to add extra information to the model number information, such as a customer-specific model number.

Serial Number

Type	Access	Range	FlowDDE	FLOW-BUS	Modbus
Unsigned char[20]	R	-	92	113/3	0xF118...0xF11F/61721...61728

This parameter consists of a maximum 20-byte string with instrument serial number for identification, for example: 'M1111111A'.

BHT Model Number

Type	Access	Range	FlowDDE	FLOW-BUS	Modbus
Unsigned char[23]	R	-	91	113/2	0xF110...0xF116/61712...61718

This parameter shows the Bronkhorst® instrument model type information.

4 Advanced operation

4.1 Reading and changing instrument parameters

4.1.1 Special parameters



All parameters described in this chapter affect the behavior of the IQ+FLOW®. Please be aware that wrong settings can disorder the output. To avoid unintentional changes, some parameters are locked (shown by the  symbol). To unlock parameters set parameter 'Init Reset' to 'Unlocked'.

Init Reset

Type	Access	Range	FlowDDE	FLOW-BUS	Modbus
Unsigned char	RW	82/64	7	0/10	0x000A/11

The 'Init Reset' parameter is used to unlock advanced parameters for writing. This parameter can be set to the following values:

Value	Mode	Instrument action
82	Locked	Advanced parameters are read-only
64	Unlocked	Advanced parameters are writeable and readable

This parameter is always set to 'Locked' at power-up.

Control Mode

Type	Access	Range	FlowDDE	FLOW-BUS	Modbus
Unsigned int	RW	0...255	12	1/4	0x0024/37

The 'Control mode' is used to select different functions of the instrument. The following modes are available:

Value	Mode	Instrument action	Setpoint source	Master source	Slave factor
0	BUS/RS232	Controlling	RS232/RS485		
1	Analog input	Controlling	Analog input		
2	FLOW-BUS slave	Controlling as slave of other instrument on bus	FLOW-BUS * slave factor / 100%	FLOW-BUS	Slave factor
3	Valve close	Close valve			
4	Controller idle	Stand-by on BUS/RS232, Controlling is stopped; Valve Out freezes in current position			
5	Testing mode	Test mode enabled (factory only)			
6	Tuning mode	Tuning mode enabled (factory only)			
7	Setpoint 100%	Controlling at setpoint 100%	Fixed 100%		
8	Valve fully open	Valve fully opened			
9	Calibration mode	Calibration mode enabled (factory only)			
10	Analog slave	Controlling as slave of other instrument on analog input	Analog input * slave factor / 100%	Analog input	Slave factor
12	Setpoint 0%	Controlling at setpoint 0%	Fixed 0%		
13	FLOW-BUS analog slave	Controlling as slave of other instrument on bus, slave factor is set with signal on analog input	FLOW-BUS * analog input * slave factor / 100%	FLOW-BUS * analog input	Analog input

Value	Mode	Instrument action	Setpoint source	Master source	Slave factor
18	RS232	Controlling	RS232		
20	Valve steering	Setpoint is redirected to Valve Out with controller idle			
21	Analog valve steering	Analog input is redirected to Valve Out with the controller idle			
22	Valve safe state				

After power-up, the control mode is set to 'Analog input' or 'BUS/RS232', depending on the customer's default setting for analog or digital operation. Except when the actual control mode setting is other than 0, 1, 9 or 18 the actual control mode setting is maintained. For more information see parameter 'IOStatus', **section 4.2.2**.



For dual interface operation or slave factors, see [Operation Instructions Digital Instruments \(document no 9.17.023\)](#)

4.1.2 Fluid information

The following parameters give information about the selected fluid range.

Fluid Number

Type	Access	Range	FlowDDE	FLOW-BUS	Modbus
Unsigned char	RW	0...7	24	1/16	0x0030/49

The 'Fluid number' is a pointer to the set of calibration parameters. Each selectable fluid has its own set of calibration parameter values. Parameter value 0 = fluid 1 and parameter value 7 = fluid 8. Up to eight fluids can be stored in an instrument. Default value = 0 (fluid 1).

Fluid Name

Type	Access	Range	FlowDDE	FLOW-BUS	Modbus
Unsigned char[10]	RW	-	25	1/17	0x8188...0x818C/33161...33165

This parameter consists of the name of the selected fluid number, e.g. 'Air'.

Capacity Unit

Type	Access	Range	FlowDDE	FLOW-BUS	Modbus
Unsigned char[7]	RW	-	129	1/31	0x81F8...0x81FB/33273...33276

The 'Fluid Unit' can be read by parameter 'Capacity Unit'. This parameter contains the unit in maximal 7 characters.

Fluid Capacity (@100%)

Type	Access	Range	FlowDDE	FLOW-BUS	Modbus
Float	RW	$\pm 1E-10$... $\pm 1E+10$	21	1/13	0x8168...0x8169/33129...33130

Capacity is the maximum value at 100% for direct reading in sensor readout units.

Fluid Capacity (@0%)

Type	Access	Range	FlowDDE	FLOW-BUS	Modbus
Float	RW	$\pm 1E-10$... $\pm 1E+10$	183	33/22	0xA1B0...0xA1B1/41393...41394

This is the capacity zero point for direct reading in sensor readout units.



For using the 'Capacity Unit Index' or 'Capacity Unit' parameters, see [Operation Instructions Digital Instruments \(document no 9.17.023\)](#)

4.1.3 Advanced measurement and control parameters

Measured Value (Fmeasure)

Type	Access	Range	FlowDDE	FLOW-BUS	Modbus
Float	R	-3.4E+38... 3.4E+38	205	33/0	0xA100...0xA101/41217...41218

Floating point variable of the 'Measured Value'. The 'Fmeasure' variable shows the measured value in the capacity and capacity unit for which the instrument has been set. The 'Fmeasure' parameter is dependent of 'Capacity', 'Capacity Unit', 'Sensor Type' and 'Capacity 0%'.

Setpoint (Fsetpoint)

Type	Access	Range	FlowDDE	FLOW-BUS	Modbus
Float	RW	0...3.4E+38	206	33/1	0xA118...0xA119/41240...41241

Floating point variable of the 'Setpoint'. The 'Fsetpoint' variable shows the setpoint value in the capacity and capacity unit for which the instrument has been set. The 'Fsetpoint' parameter is dependent of 'Capacity', 'Capacity Unit', 'Sensor Type' and 'Capacity 0%'.

Valve Output

Type	Access	Range	FlowDDE	FLOW-BUS	Modbus
Unsigned long	RW	0... 16777215	55	114/1	0xF208...0xF209/61961...61962

This parameter is the signal coming out of the controller, used for driving the valve. 0...16777215 corresponds with approximately 0...60 mA_{dc}.

4.1.4 Controller parameters

The controlling algorithm for the valve handled by the micro-controller consists of several parameters which can be set. Although many parameters could be accessed, Bronkhorst advises not to change these parameters because during manufacturing the controller is optimized. Changing of controller settings should be performed by or under supervision from trained service personnel only.

The picture below shows the basic controller diagram of the digital instrument. It consists of a standard PID controller with a number of add-ons. Basically, when a faster or slower controller response is needed, only the controller speed (K_{speed}) or PID-K_p should be changed.

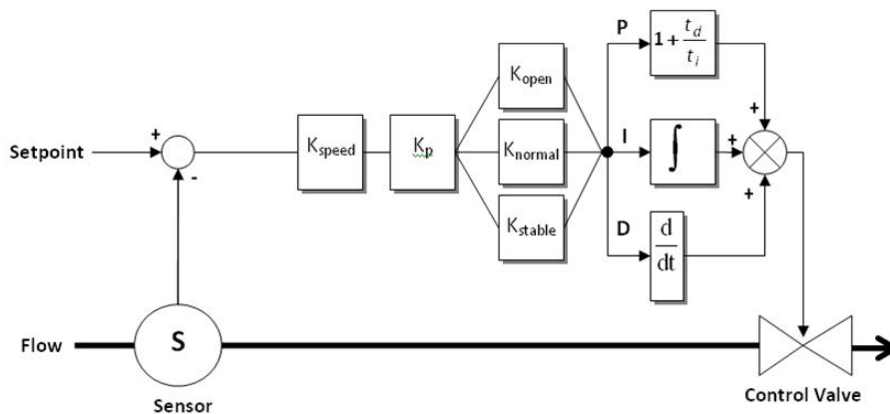

K_p (PID-K_p)

Type	Access	Range	FlowDDE	FLOW-BUS	Modbus
Float	RW	0...1E+10	167	114/21	0xF2A8...0xF2A9/62121...62122

PID controller proportional action, multiplication factor.

Controller Speed (Kspeed)

Type	Access	Range	FlowDDE	FLOW-BUS	Modbus
Float	RW 	0...3.4E+38	254	114/30	0xF2F0...0xF2F1/62193...62194

This parameter is the controller speed factor. PID-Kp is multiplied by this factor.

Ti (PID-Ti)

Type	Access	Range	FlowDDE	FLOW-BUS	Modbus
Float	RW 	0...1E+10	168	114/22	0xF2B0...0xF2B1/62129...62130

PID controller integration action in seconds. This value should not be changed.

Td (PID-Td)

Type	Access	Range	FlowDDE	FLOW-BUS	Modbus
Float	RW 	0...1E+10	169	114/23	0xF2B8...0xF2B9/62137...62138

PID controller differentiation action in seconds. The default value is 0.0. This value should not be changed.

Open from Zero control response (Kopen)

Type	Access	Range	FlowDDE	FLOW-BUS	Modbus
Unsigned char	RW 	0...255	165	114/18	0x0E52/3667

Controller response when starting-up from 0% (when valve opens). Value 128 is default and means: no correction. Otherwise controller speed will be adjusted as follows:

$$\text{New response} = \text{Old response} \cdot 1.05^{(128 - K_{\text{speed}})}$$

Normal Step response (Knormal)

Type	Access	Range	FlowDDE	FLOW-BUS	Modbus
Unsigned char	RW 	0...255	72	114/5	0x0E45/3654

Controller response during normal control (at setpoint step). Value 128 is default and means: no correction. Otherwise controller speed will be adjusted as follows:

$$\text{New response} = \text{Old response} \cdot 1.05^{(128 - K_{\text{normal}})}$$

Stable Situation control response (Kstable)

Type	Access	Range	FlowDDE	FLOW-BUS	Modbus
Unsigned char	RW 	0...255	141	114/17	0x0E51/3666

Controller response when controller is stable (within band of 2% of setpoint). Value 128 is default and means: no correction. Otherwise controller speed will be adjusted as follows:

$$\text{New response} = \text{Old response} \cdot 1.05^{(128 - K_{\text{stable}})}$$

4.1.5 Display filter

The output signal of an IQ+FLOW® instrument (measured value) is filtered. Filter behavior is dynamic: when a change in sensor signal is detected, the measured value will be less filtered than when the sensor signal is constant and stable. There are two filter constants: Static Display Factor and Dynamic Display Factor. These two factors can be transformed into time constants using the following formula:

$$\tau = \text{cycletime} \cdot \frac{1 - \text{factor}}{\text{factor}}$$

The measured value is filtered with a first order low pass filter with a filter time constant between the two τ values.

Dynamic Display Factor

Type	Access	Range	FlowDDE	FLOW-BUS	Modbus
Float	RW 	0...1.0	56	117/1	0xF508...0xF509/62729...62730

This value should not be changed.

Static Display Factor

Type	Access	Range	FlowDDE	FLOW-BUS	Modbus
Float	RW 	0...1.0	57	117/2	0xF510...0xF511/62737...62738

This value should not be changed.

CycleTime

Type	Access	Range	FlowDDE	FLOW-BUS	Modbus
Unsigned char	R	0...255	52	114/12	0x0E4C/3661

Note: The unit of parameter CycleTime is 10 ms. Example: value 0.2 means 2 ms

4.1.6 Alarm / Status parameters

See [Operation Instructions Digital Instruments \(document no 9.17.023\)](#)

4.1.7 Counter parameters

See [Operation Instructions Digital Instruments \(document no 9.17.023\)](#)

4.2 Special instrument features**4.2.1 Auto zeroing**

To start the auto zero-procedure by digital operation two parameters should be written:

Control Mode

Type	Access	Range	FlowDDE	FLOW-BUS	Modbus
Unsigned char	RW	0...255	12	1/4	0x0024/37

Calibration Mode

Type	Access	Range	FlowDDE	FLOW-BUS	Modbus
Unsigned char	RW 	0...255	58	115/1	0x0E61/3682

Value	Mode	Instrument action
0	Idle	Idle
9	Auto zero	Auto-zeroing
255	Error	Idle

Auto-zero procedure:

Step 1: Set 'Control Mode' to 'Calibration Mode' (value 9)

Step 2: Set 'Calibration Mode' to 'Auto zero' (value 9)

Step 3: Check 'Calibration Mode',

Idle (value 0)	Auto-zeroing succeeded
Auto zero (value 9)	Auto-zeroing active
Error (value 255)	Auto-zeroing failed

4.2.2 Changing default control mode

Instruments are delivered with either analog or digital signal as default, depending on customer's requirement. After every (power-up) reset the instrument will return to its default control mode. The default control mode can be changed with the following parameter:

IOStatus

Type	Access	Range	FlowDDE	FLOW-BUS	Modbus
Unsigned char	RW 	0...255	86	114/11	0xF258...0xF259/62041...62042

Bit 6 [7...0] represents the former analog jumper.

1 = default control mode is analog

0 = default control mode is digital

Procedure for changing default digital operation to default analog operation:

- Read 'IOStatus'
- Add 64 to the read value
- Write 'IOStatus'

Procedure for changing default analog operation to default digital operation:

- Read 'IOStatus'
- Subtract 64 from the read value
- Write 'IOStatus'



Control mode can also be changed by means of the [micro-switch](#)

4.2.3 Disabling micro switch (single-channel versions only)

It is possible to disable the micro-switch on top of the instrument. This can prevent undesired use of this button. Disabling the micro-switch can be performed with the following parameter:

IOStatus

Type	Access	Range	FlowDDE	FLOW-BUS	Modbus
Unsigned char	RW 	0...255	86	114/11	0xF258...0xF259/62041...62042

Bit 3 [7...0] is used to disable the micro-switch.

0 = micro-switch disabled

1 = micro-switch enabled

Procedure to enable the micro-switch:

- Read 'IOStatus'
- Add 8 to the read value $(OR[0x08])$
- Write 'IOStatus'

Procedure to disable the micro-switch:

- Read 'IOStatus'
- Subtract 8 from the read value $(AND[\overline{0x08}])$
- Write 'IOStatus'

4.2.4 Setting digital output (multi-channel versions only)

The IQ+FLOW® multi-channel pc-board is equipped with three digital outputs. The digital outputs can be used for driving shut-off valves (for instance). The digital outputs can be read or written via the parameter 'IO Switch Status'. The parameters can be set as indicated in the value table below. Note that this parameter is channel-independent. Each output can be accessed via all channels. E.g. by writing this parameter via channel 2, it is possible to open/close a shut-off valve located at channel 1.

IO Switch Status

Type	Access	Range	FlowDDE	FLOW-BUS	Modbus
Unsigned long	RW	0...7	288	114/31	0xF2F8/62201

Value	Status output 1	Status output 2	Status output 3
0	Off	Off	Off
1	On	Off	Off
2	Off	On	Off
3	On	On	Off
4	Off	Off	On
5	On	Off	On
6	Off	On	On
7	On	On	On

4.2.5 Changing slave address, baud rate and parity

Changing node address or baud rate by micro-switch operation

Press the micro-switch 5x briefly with intervals of max. 1 second in normal running/operation mode. Within the timeout period of 60 seconds it is possible to start changing the node address and baud rate of the instrument.

Step	Action	Indication	Time	Handling
1	Start			Press the switch 5x briefly with intervals of max. 1 second in normal running/operation mode.
2	Set tens of bus address	■ Green LED flashes 0.1 sec on, 0.1 sec off count flashes start when switch is pressed: 0.5 sec on, 0.5 sec off	timeout: 60 sec	Press switch and count green flashes for tens of bus address. Release when wanted amount has been count. Counts up to max. 12 and than starts at 0 again. When counting fails, keep switch pressed and restart counting for next attempt.
3	Set units of bus address	■ red LED flashes 0.1 sec on, 0.1 sec off count flashes start when switch is pressed: 0.5 sec on, 0.5 sec off	timeout: 60 sec	Press switch and count red flashes for units of bus address. Release when wanted amount has been count. Counts up to max. 9 and than starts at 0 again. When counting failed, keep switch pressed and restart counting for next attempt.
4	Set baud rate of field bus communication. 1 = 9600 Baud 2 = 19200 Baud 3 = 38400 Baud 4 = 56000 Baud 5 = 57600 Baud 6 = 115200 Baud	both ■ red and ■ green LEDs flashes 0.1 sec on, 0.1 sec off count flashes start when switch is pressed: 0.5 sec on, 0.5 sec off	timeout: 60 sec	Press switch and count red and green flashes for baud rate setting. Release when wanted amount has been count. Counts up to max. 5 and than starts at 0 again. When counting failed, keep switch pressed and restart counting for next attempt. Note: selection of 0 means: No change

Instrument returns to normal running / operation mode. Changes are valid when they are made within the time-out times.



Value zero will be indicated by a period of 1 sec off (0.5 sec off + 0,5 sec off).
When value zero is wanted, press switch shortly and release it again within 1 sec.



Before each action of flash-counting, the LEDs to be used for counting will flash in a high frequency.
(Pattern: 0.1 sec on, 0.1 sec off). As soon as the switch is pressed-down, this LED (or both LEDs) will be off and the counting sequence will start.

Changing node address, baud rate or parity in 'Configuration Mode' or in normal mode

The procedure for changing the baud rate, node address or parity for a FLOW-BUS or Modbus configuration over RS485 is described in **section 3.5.3** (single-channel versions only). In the list below the selectable bus parameters with corresponding values are presented.



When changing any of the parameters below in normal running/operation mode the communication with the instrument may be lost. After a restart the instrument is available for communication on the newly selected parameters. When in doubt activate the 'Configuration Mode' (38k4 and RS232 FLOW-BUS (ProPar)) using the micro-switch.

Fieldbus 2 selection

Type	Access	Range	FlowDDE	FLOW-BUS	Modbus
Unsigned char	RW	0...3	308	124/8	0xFC40/64577

This parameter sets the fieldbus type. Parameter value 0 = FLOW-BUS, 1 = Modbus RTU, 2 = Propar, 3 = Modbus ASCII

Fieldbus 2 address

Type	Access	Range	FlowDDE	FLOW-BUS	Modbus
Unsigned char	RW	0...255	309	124/10	0xFC50/64593

Set the node address at any of the allowed values listed in the table in **Section 3.5.3**, e.g. '3'.

Fieldbus 2 baud rate

Type	Access	Range	FlowDDE	FLOW-BUS	Modbus
Unsigned char	RW	0...1E+10	310	124/9	0xFC48...0xFC49/64585...64586

Set the baud rate at any of the allowed values listed in table in section **Section 3.5.3**, e.g. '19200'.

Fieldbus 2 medium

Type	Access	Range	FlowDDE	FLOW-BUS	Modbus
Unsigned char	RW	0...1	311	124/11	0xFC58/64601

Select the communication medium. Parameter value 0 = RS232, 1 = RS485

Fieldbus 2 parity

Type	Access	Range	FlowDDE	FLOW-BUS	Modbus
Unsigned char	RW	0...2	336	124/12	0xFC60/64609

Set the parity for Modbus communication. Parameter value 0 = None, 1 = Odd, 2 = Even.

5 Troubleshooting and service

5.1 General

For a correct analysis of the proper operation of an instrument it is recommended to remove the unit from the process line and check it without applying fluid supply pressure. In case the unit is dirty or clogged, this can be ascertained immediately by loosening the fittings and inspecting visually.

Energizing or de-energizing of the instrument indicates whether there is an electronic failure. After energizing, fluid pressure is to be applied in order to check behaviour. If there should be suspicion of leakage, do not disassemble the sensor for inspection but contact your local distributor for service or repairs.

5.2 LED indication

The red LED on the instrument gives error or warning information.

Red LED	Time	Indication
Off	Continuously	No error
On	Continuously	Critical error message. A serious error occurred in the instrument. Instrument needs service before further use



For more information check [Operation Instructions Digital Instruments \(document no 9.17.023\)](#)

5.3 Troubleshooting summary general

Symptom	Possible cause	Action
No output signal	No power supply	Check power supply and hook-up
		Check cable connection and hook-up.
		Check status of LEDs; see Operation Instructions Digital Instruments (document no 9.17.023)
	Cable damaged or hooked-up incorrectly	Check and compare signals at both ends of cable.
	PC-board damaged due to long lasting shortage and/or high-voltage peaks	Return to factory
	No or too low inlet pressure	Increase inlet pressure
		Open shut-off at inlet and outlet
	Supply pressure too high, or differential pressure across meter too high	Reduce supply pressure
	Sensor failure	Return to factory
Maximum output signal	Sensor failure	Return to factory
Output signal much lower than setpoint signal or desired flow	Incorrect type of fluid or too low inlet pressure	Test instrument on conditions for which it was designed
Oscillation / Signal noise	Pressure regulator of supply pressure is oscillating or wrong sized	Replace pressure regulator
Small flow indication when flow is definitely zero	Increased zero reading without flow caused by raised zero-point	Perform an auto-zero action
No digital communication	Occupied or wrong bus address	Change address with software

5.4 Service

If you have questions about the product or if you feel the product does not meet the specifications agreed upon, do not hesitate to contact us. To enable us to help you quickly and effectively, make sure to have the serial number ready whenever seeking contact with Bronkhorst about a specific item. The serial number (SN) is the key to the original purchase order and can be found on the product.

For current information on Bronkhorst® and service addresses, please visit our website:



www.bronkhorst.com

Do you have any questions about our products? Our Sales Department will gladly assist you selecting the right product for your application. Contact sales by e-mail:



sales@bronkhorst.com

For after-sales questions, our Customer Service Department is available with help and guidance. To contact CSD by e-mail:



support@bronkhorst.com

No matter the time zone, our experts within the Support Group are available to answer your request immediately or ensure appropriate further action. Our experts can be reached at:



+31 859 02 18 66

Bronkhorst High-Tech B.V.
Nijverheidsstraat 1A
NL-7261 AK Ruurlo
The Netherlands

6 Returns

6.1 Removal and return instructions

When returning materials, always clearly describe the problem, and, if possible, the work to be done, in a covering letter.

Instrument handling:

1. Purge all fluidic lines (if applicable)
2. If toxic or dangerous fluids have been used, the instrument must be cleaned before shipping
3. Disconnect all external cabling and tubing and remove the instrument from the process line
4. If applicable, secure movable parts with appropriate transport safety materials, to prevent damage during transportation
5. The instrument must be at ambient temperature before packaging
6. Insert the instrument into a plastic bag and seal the bag
7. Place the bag in an appropriate shipping container; if possible, use the original packaging box

Add documentation:

- Reason of return
- Failure symptoms
- Contaminated condition
- Declaration on decontamination



It is absolutely required to notify the factory if toxic or dangerous fluids have been in contact with the device!
This is to enable the factory to take sufficient precautionary measures to safeguard the staff in their repair department.

All instruments must be dispatched with a completely filled in 'Declaration on decontamination'. Instruments without this declaration will not be accepted.



A safety information document containing a 'Declaration on decontamination' form (document no 9.17.032) can be downloaded from the **Service & Support** section of the Bronkhorst website (www.bronkhorst.com).

Important:

Clearly note, on top of the package, the customs clearance number of Bronkhorst High-Tech B.V.:

NL801989978B01

(only if applicable, otherwise contact your local Bronkhorst representative for local arrangements.)

6.2 Disposal (end of lifetime)

Within the scope of the European Union, manufacturers of electrical and electronic equipment (EEE) are bound to comply with the WEEE Directive (Waste Electrical and Electronic Equipment). As a consequence, Bronkhorst is obligated to offer its customers in the EU the possibility to return EEE for disposal once it has reached the end of its lifetime, and take all necessary steps to dismantle it properly and recycle or re-use its components whenever possible.

All Bronkhorst® products that fall under the regime of the WEEE Directive (which is the majority) have an image of a crossed-out wheeled bin printed somewhere on the product (typically the serial number label). If you wish to dispose of Bronkhorst® equipment bearing this symbol, you can simply return it in accordance with the [removal and return instructions](#), and Bronkhorst will take care of proper dismantlement and recycling. In the covering letter, just mention that you are returning the product for disposal. Within the EU, returning products for disposal is of course free of charge (except for shipping and handling costs).



For customers outside the EU, local or national directives and/or legislation may apply to EEE disposal. If applicable, consult local or national authorities to learn how to handle EEE properly in your area.